

THE PROPERTY OF THE DRAWING IS ESTABLISHED BY LAW. IT IS FORBIDDEN TO PRODUCE OR SHOW IT TO THIRD PART. WITHOUT A WRITTEN AGREEMENT.

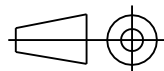
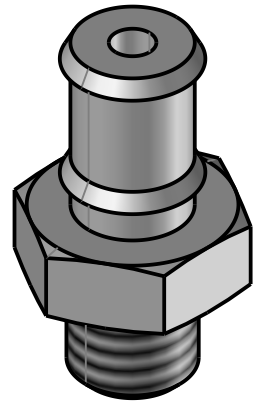
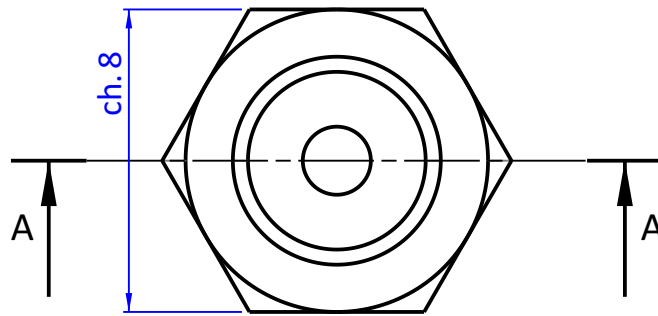
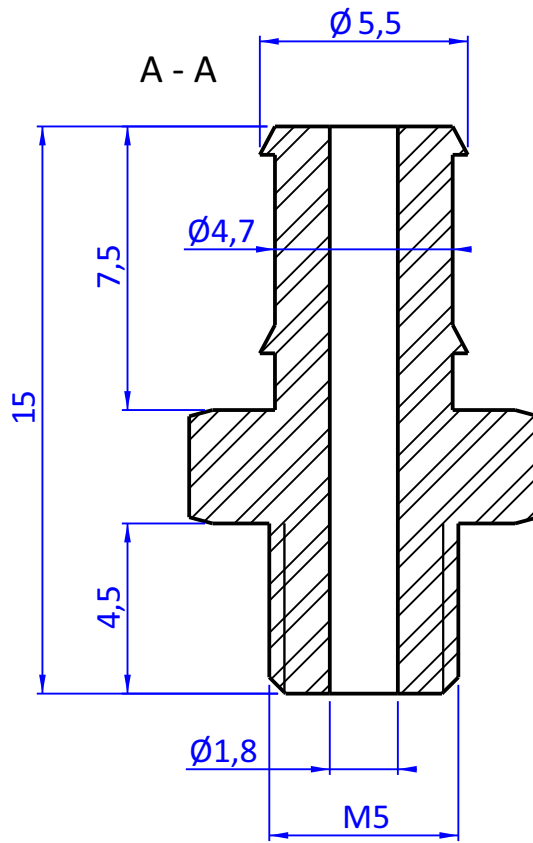

DESIGNED FROM		REVIEW
FPS Automation		A
DATE	WEIGHT	
02/09/2022	0,001kg	
CODE		
CA.08.09.040		

Format	A4
UNI 936-76	

GENERAL TOLERANCE
UNI - ISO 2768
CLASSE f

DESCRIPTION
CA.08.09.040